

NO:01049

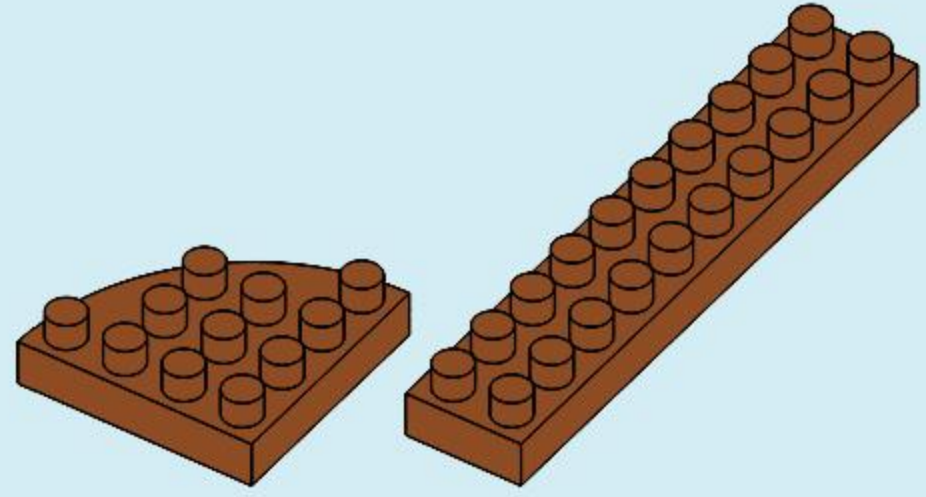

X4

X1

1

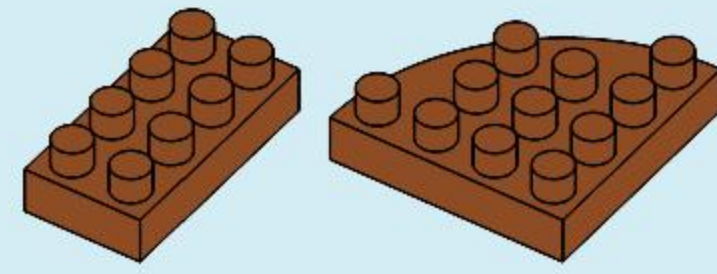
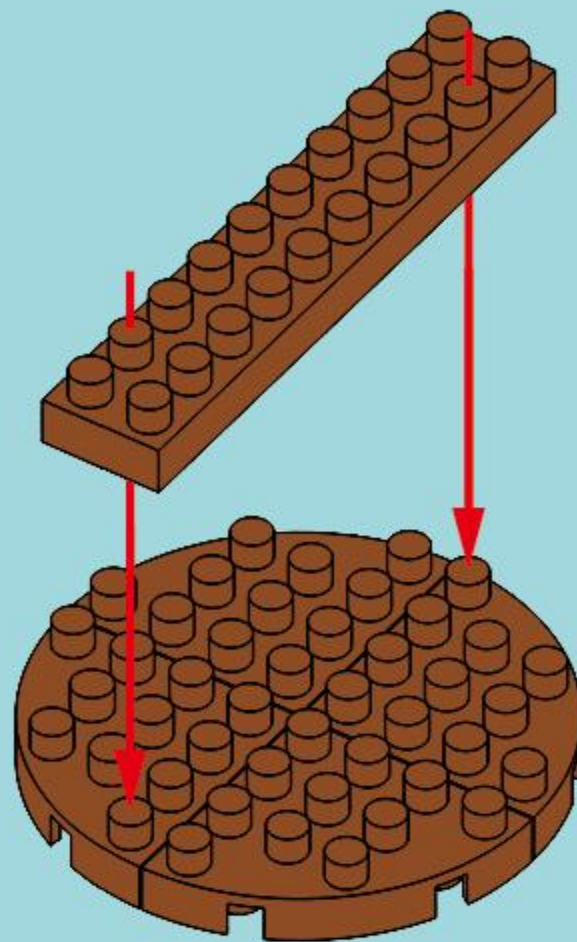

X2

X4

2

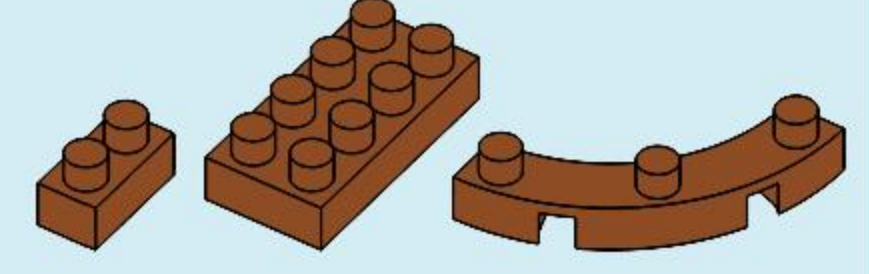
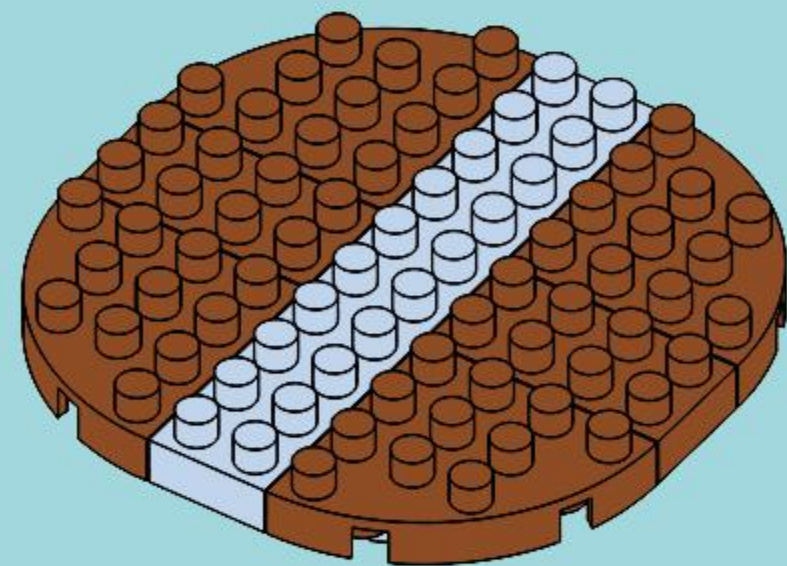

X4

X2

X4

3



X4

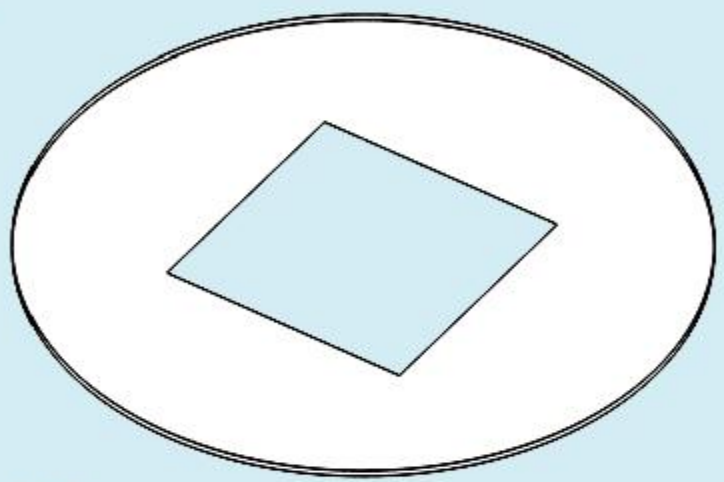
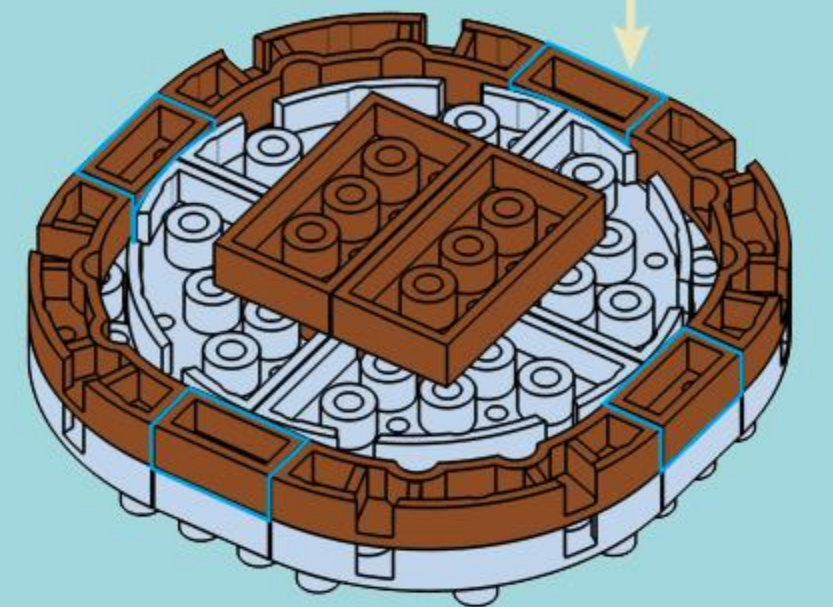

X1

4

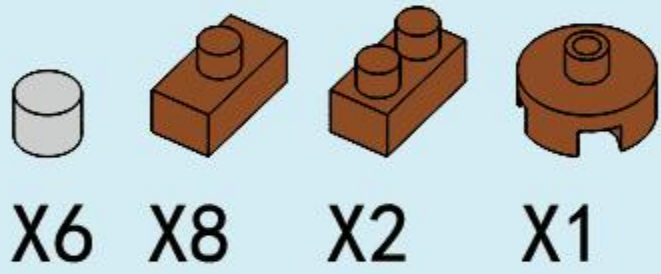
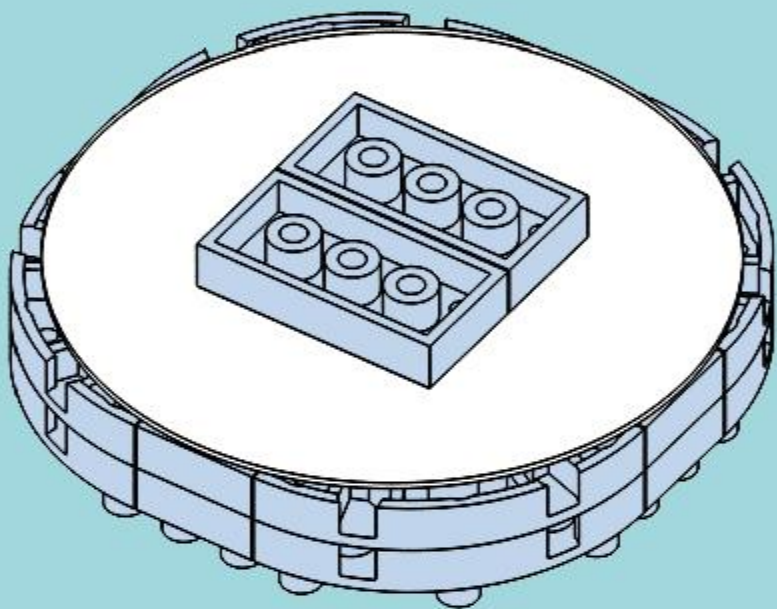

X6

X8

X2

X1

5

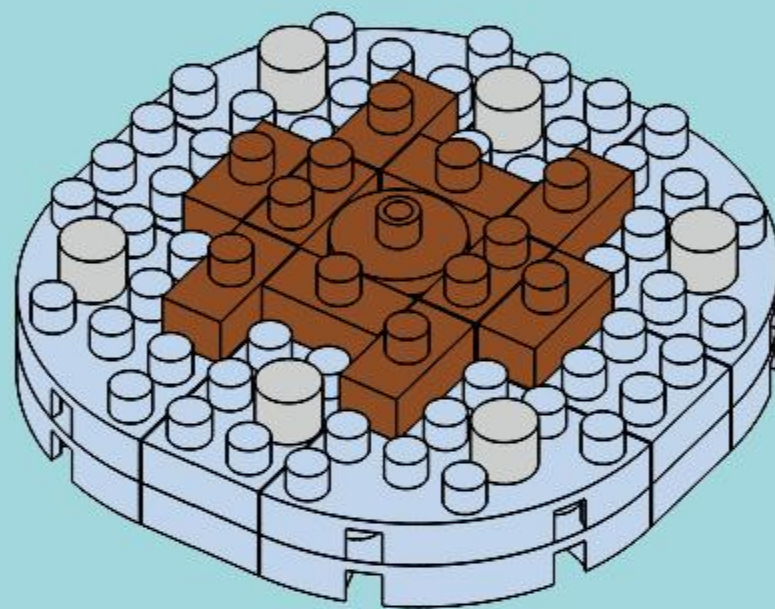

X12

6

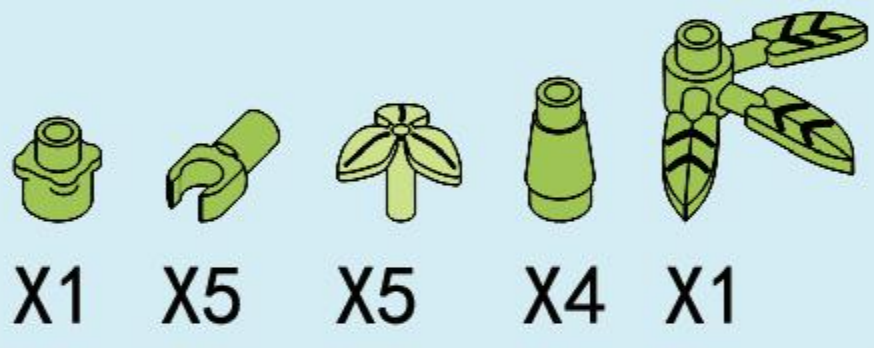
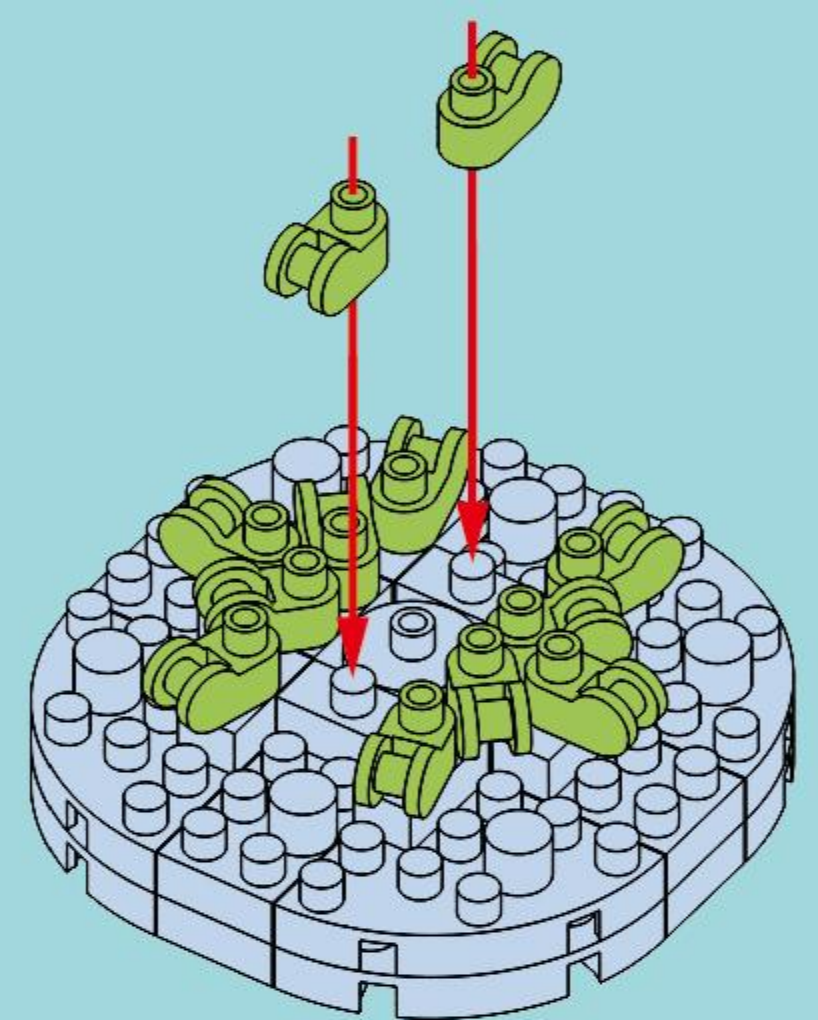

X1

X5

X5

X4

X1

7

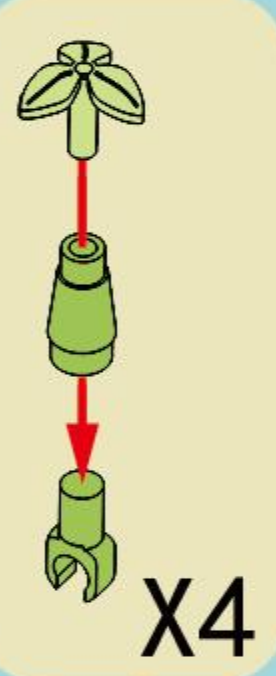

X4

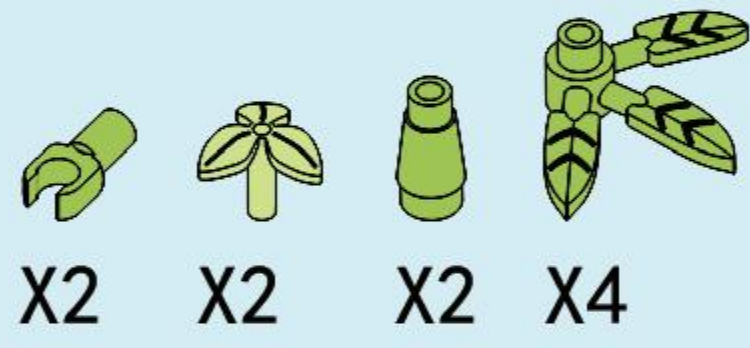
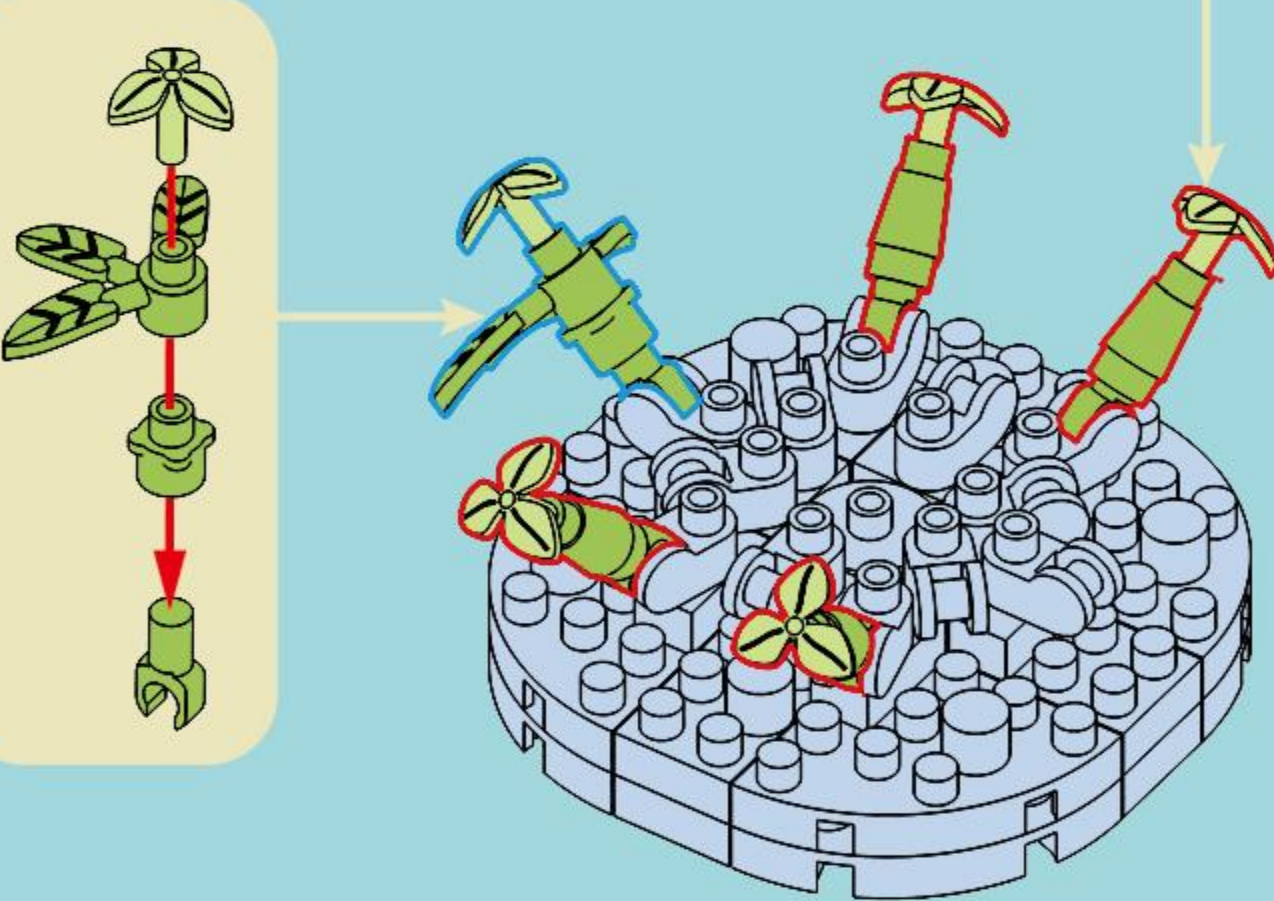

X2

X2

X2

X4

8

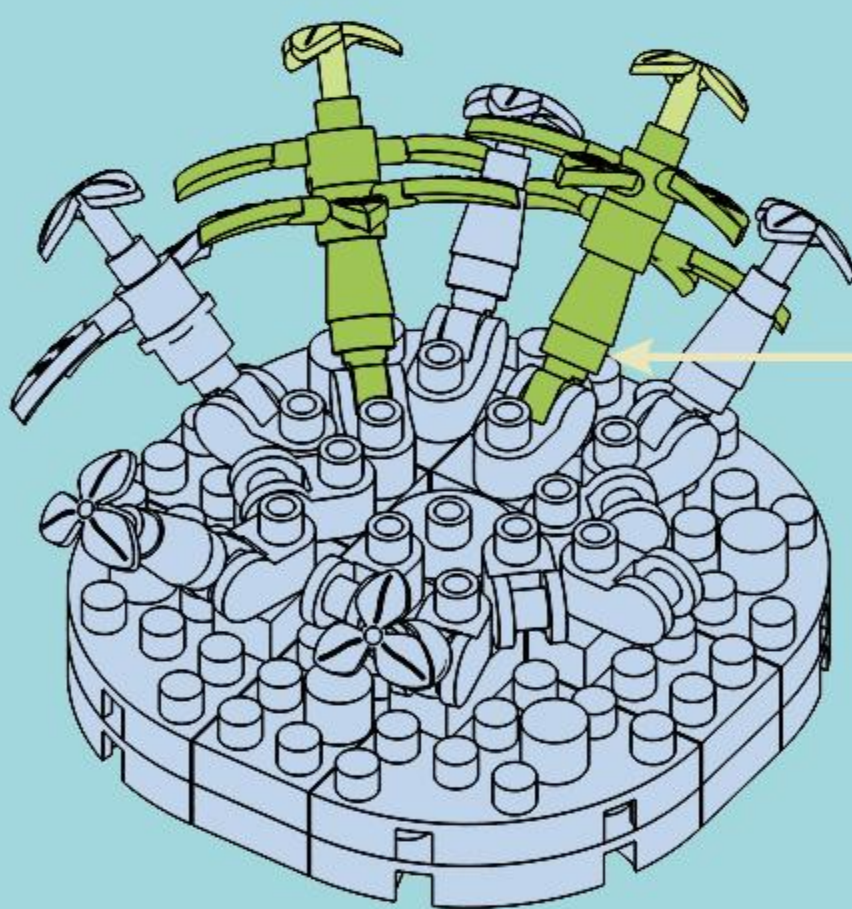

X3

X3

X3

X6

9

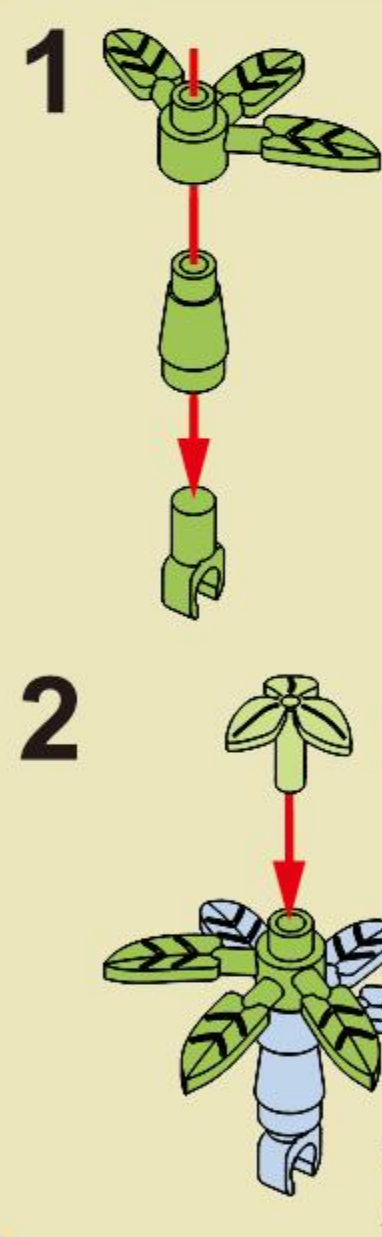

1

2

X2

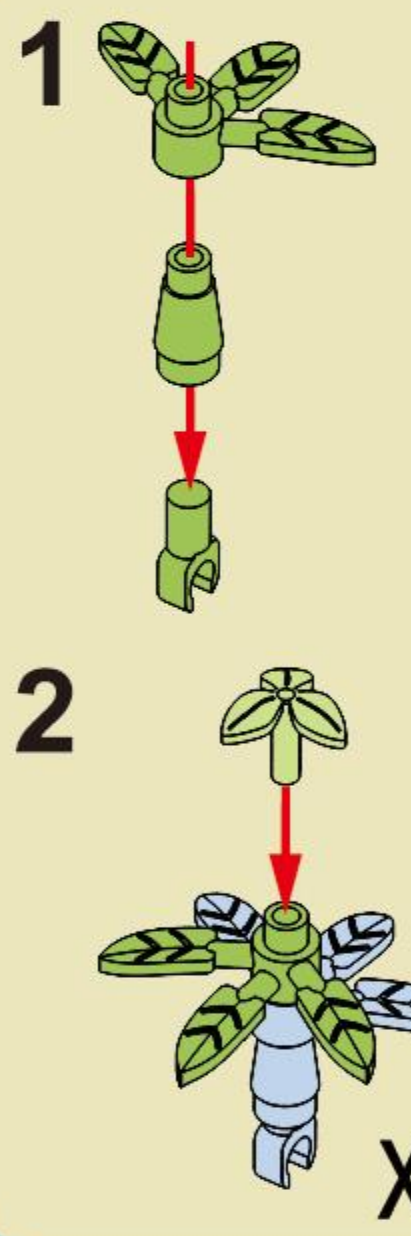
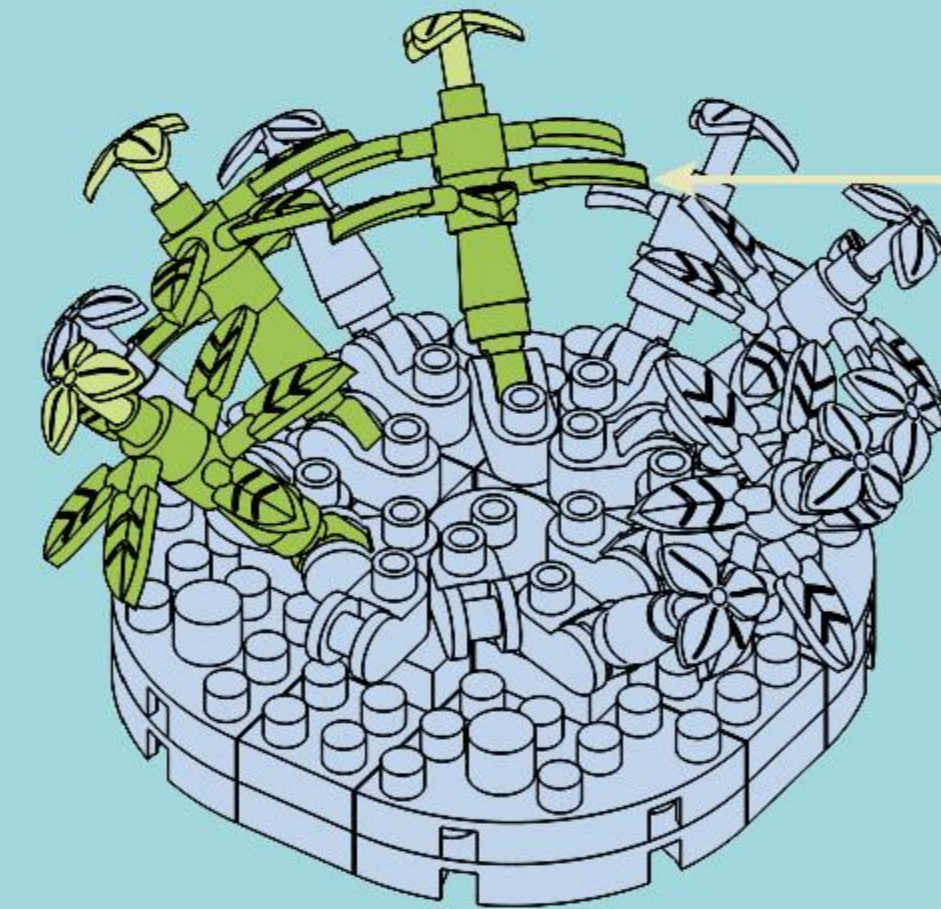

1

2

X3

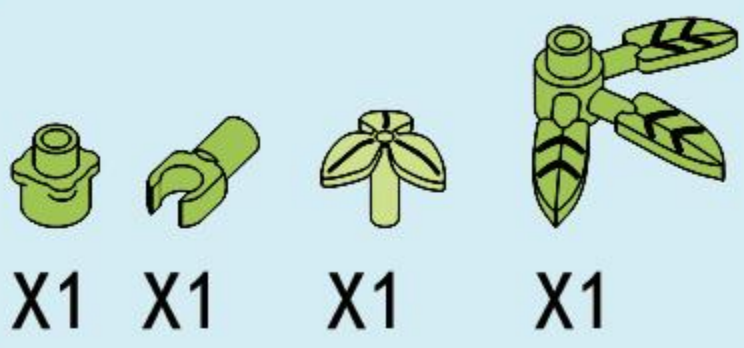

X1

X1

X1

X1

10

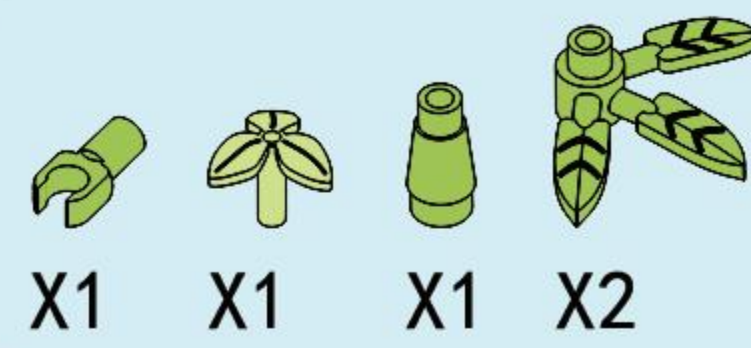
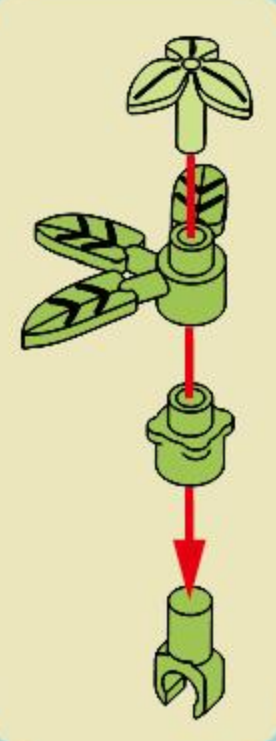
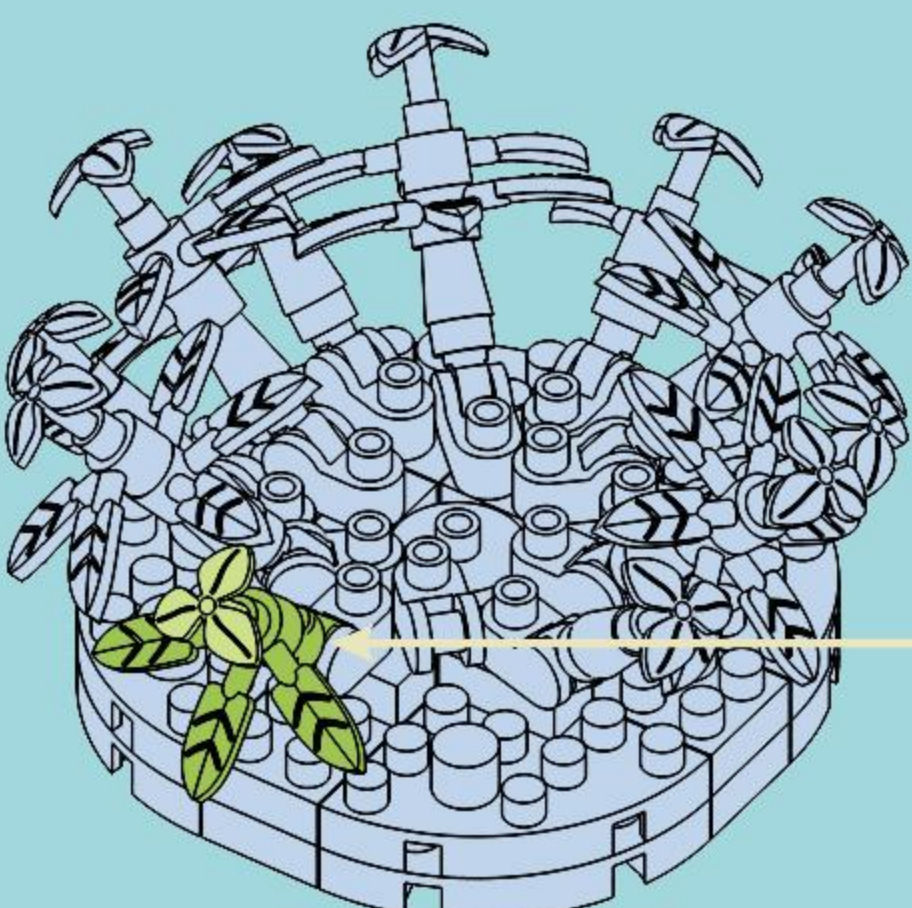

X1

X1

X1

X2

11

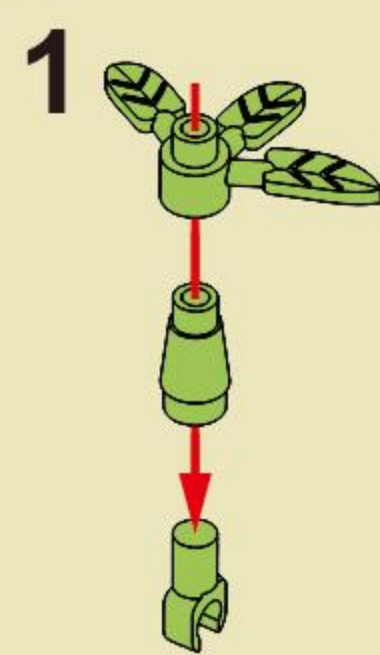

1

2

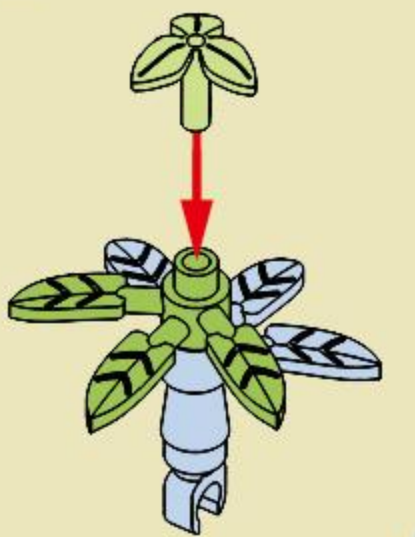

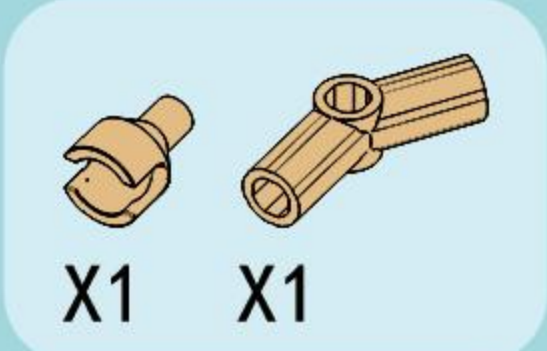

12

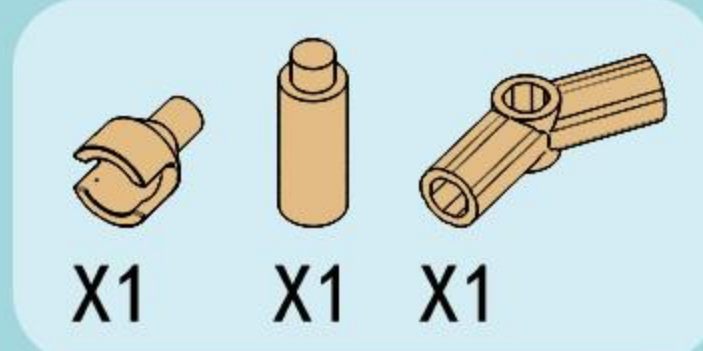
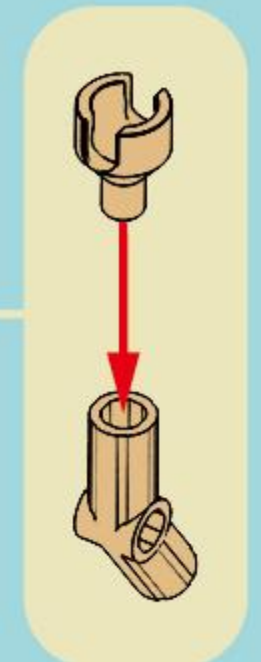
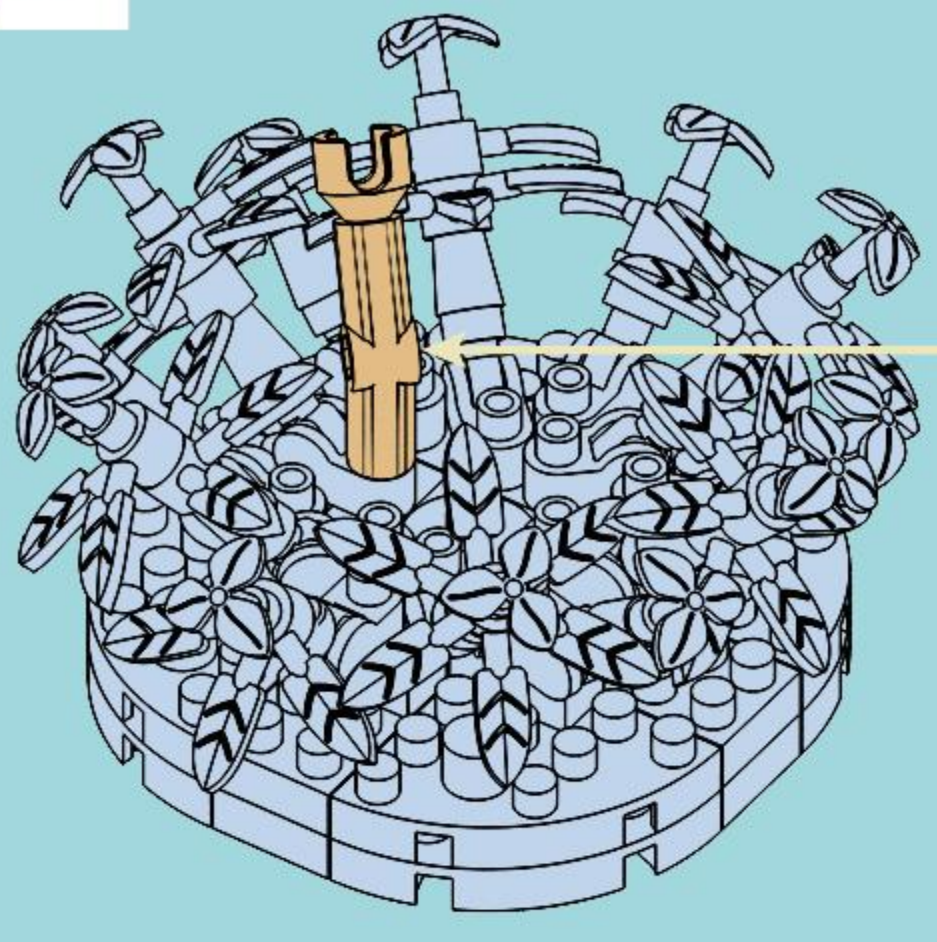

13

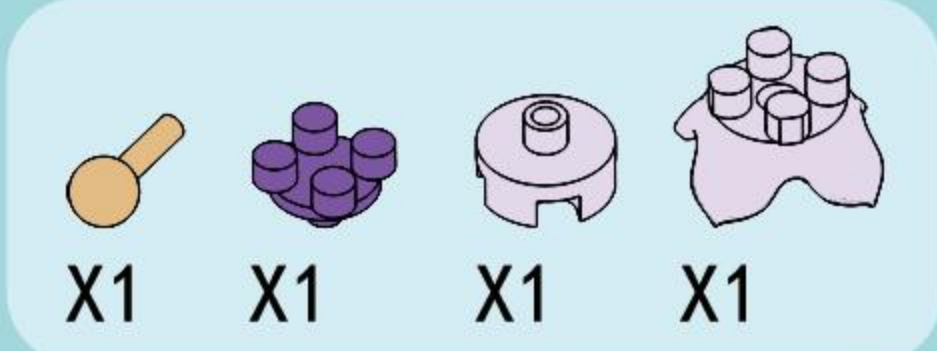
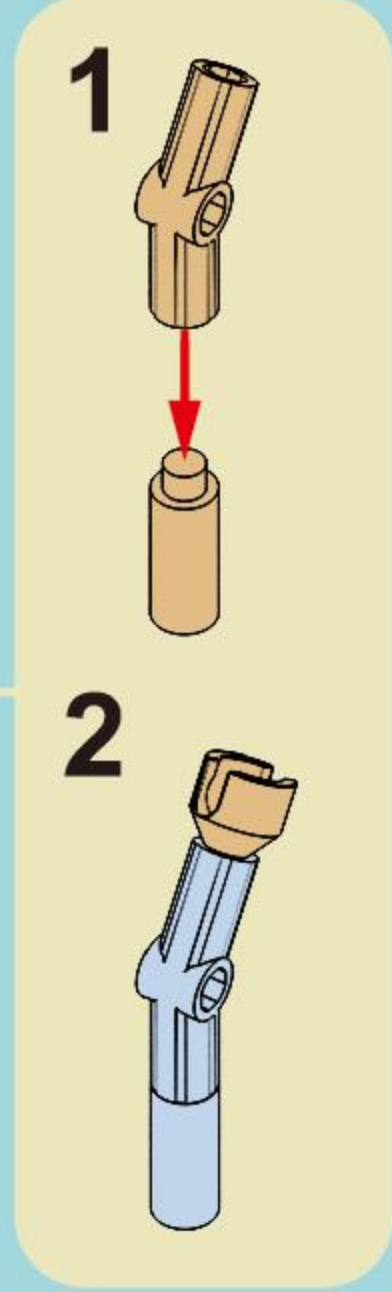

14

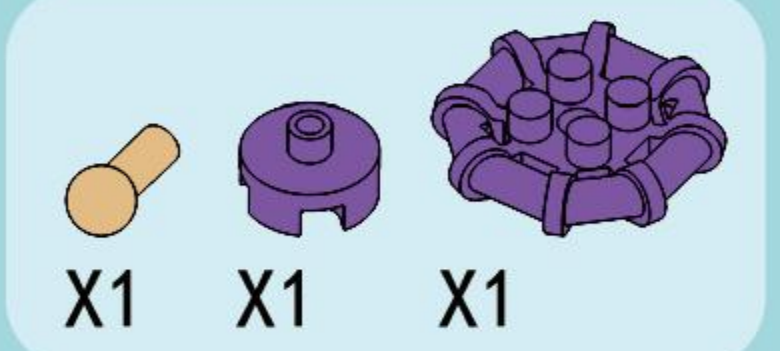
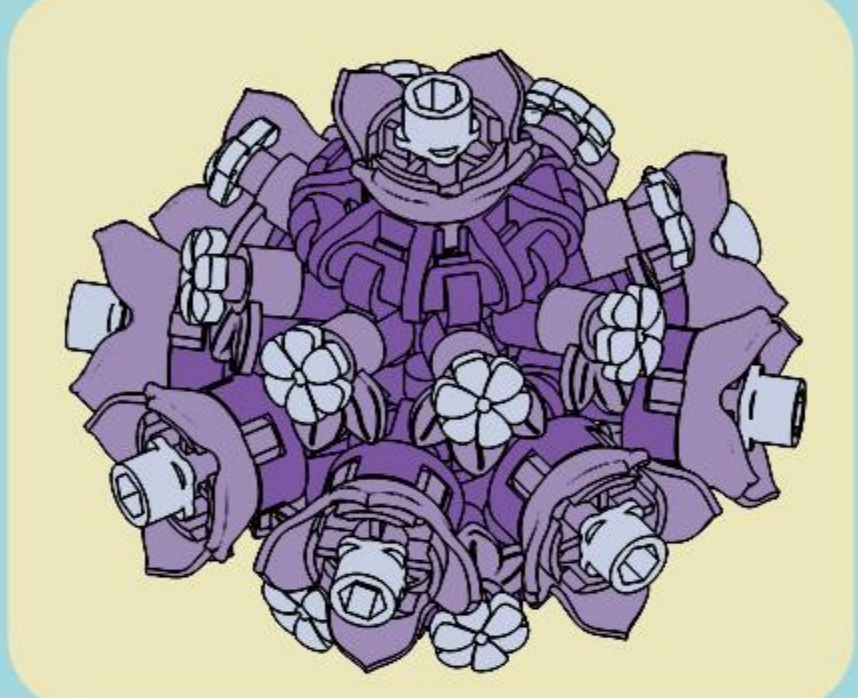
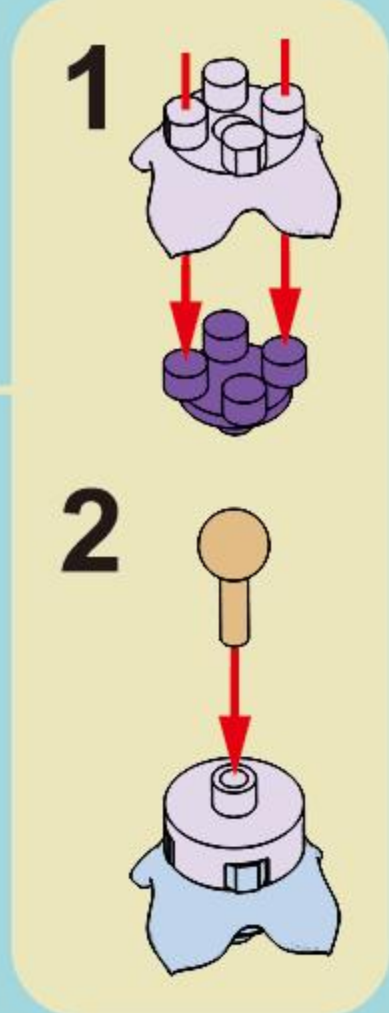
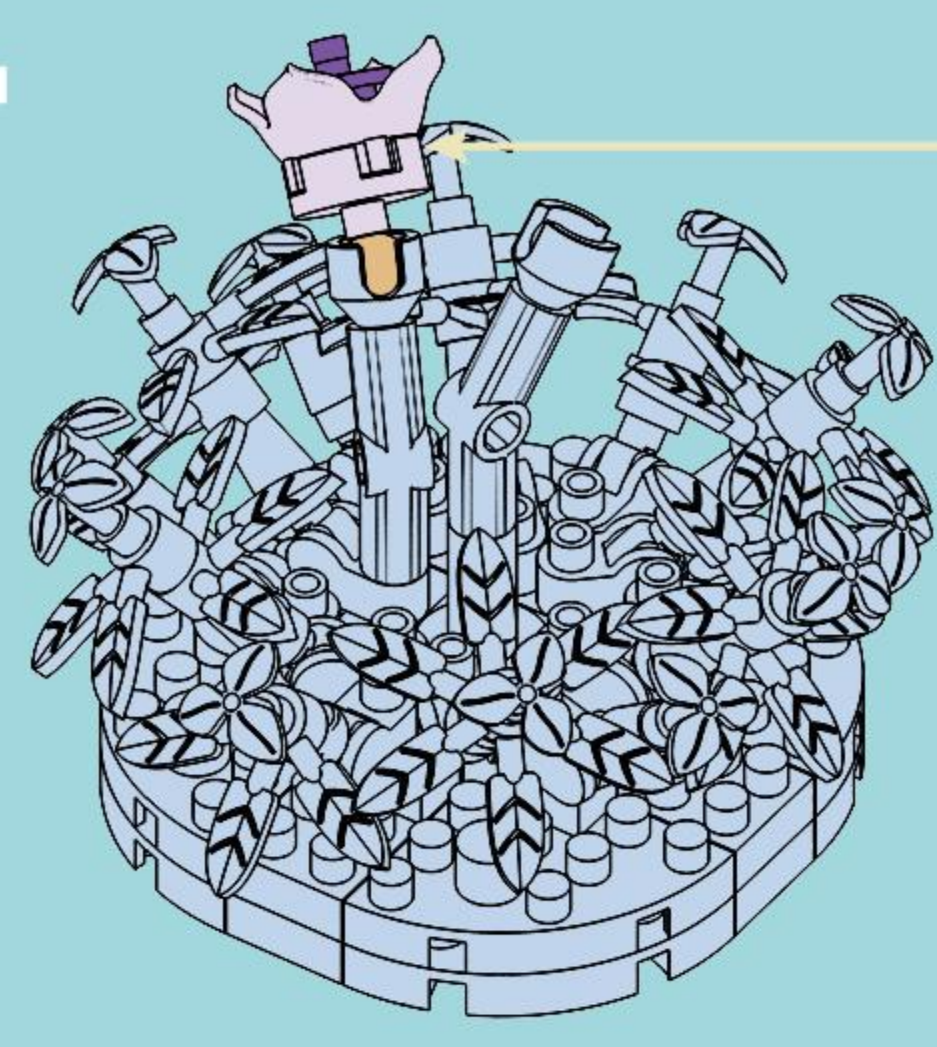

15

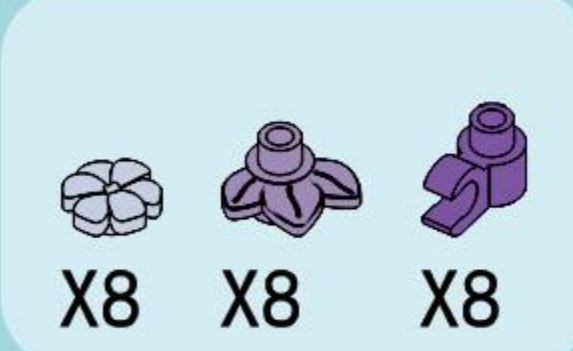
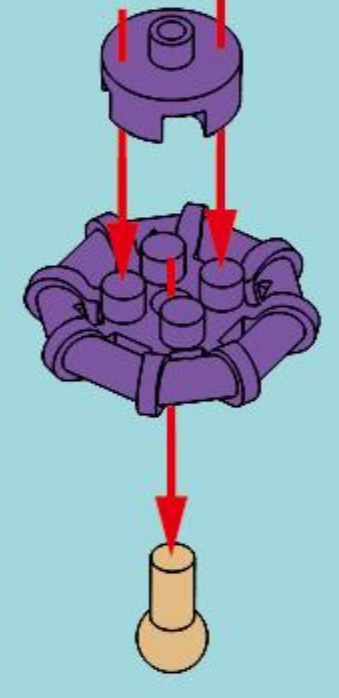

16

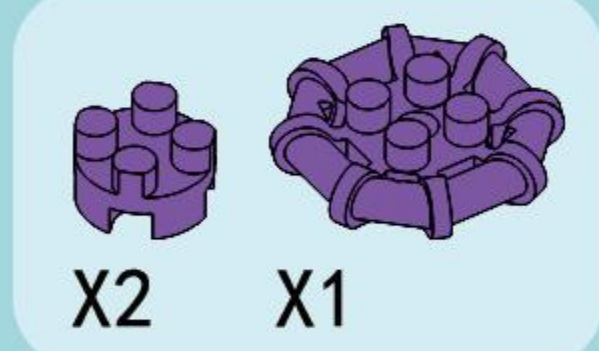
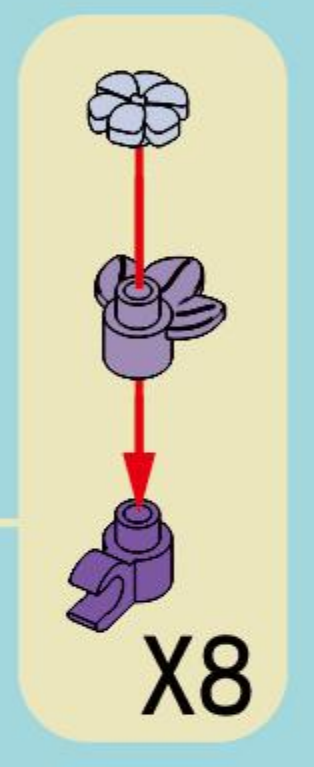
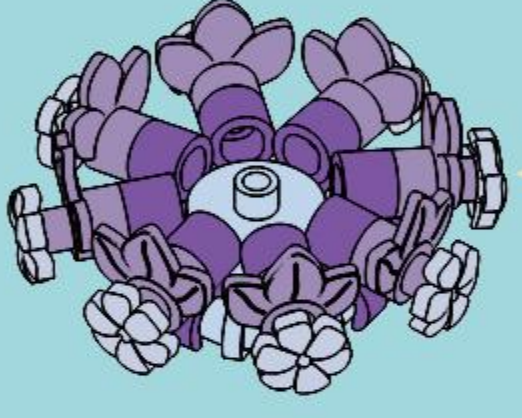

17

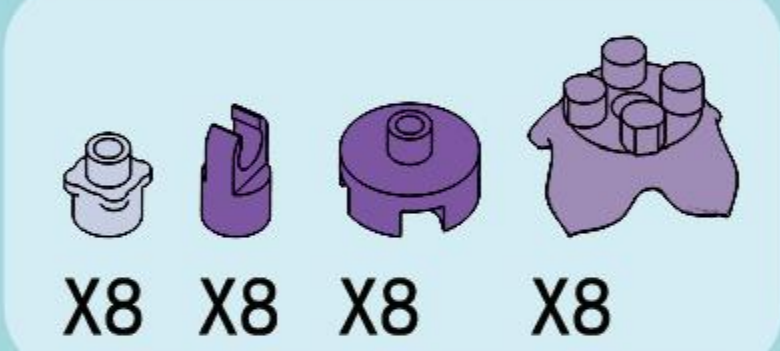
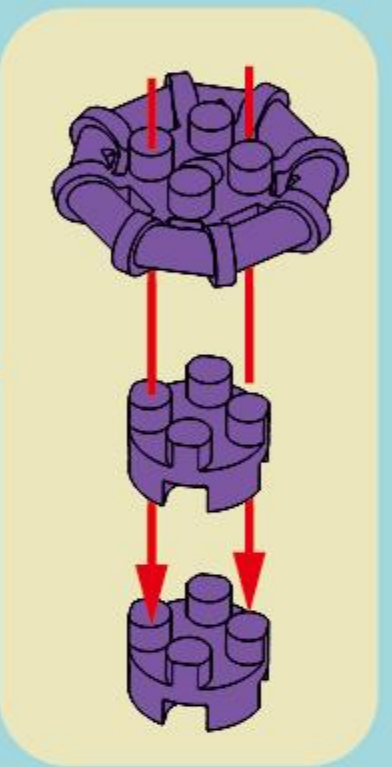
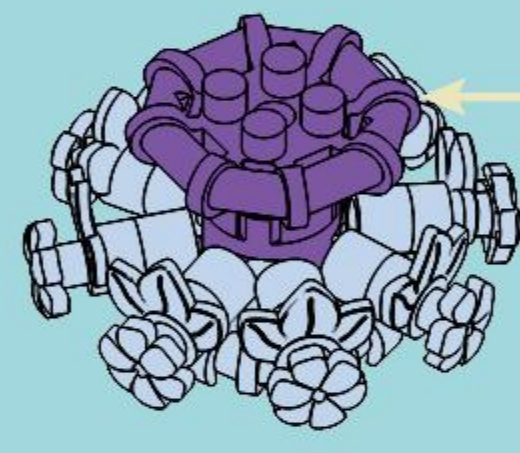

18

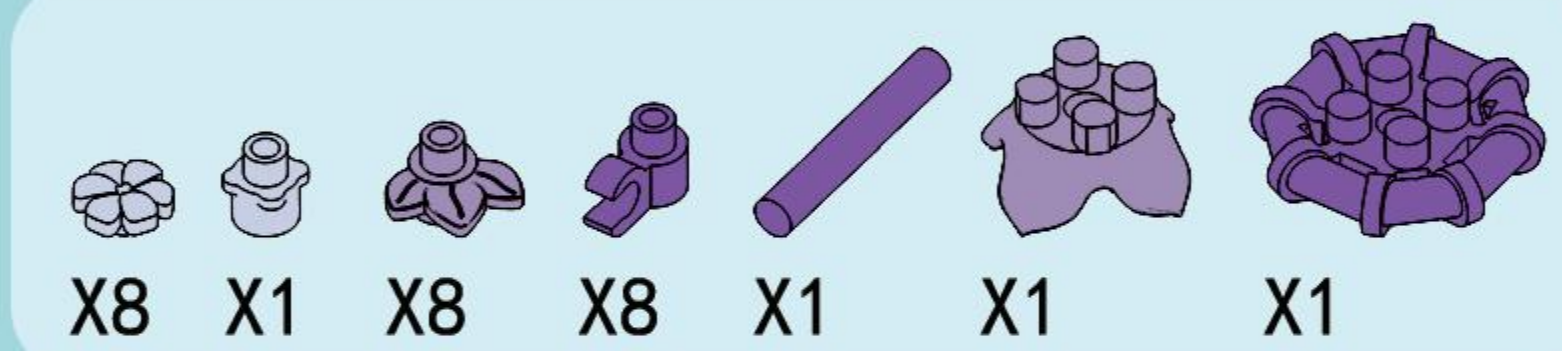
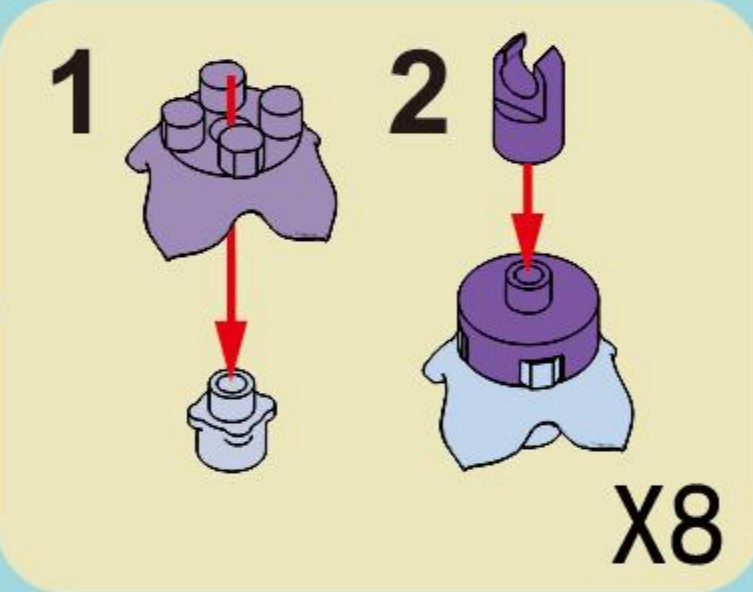
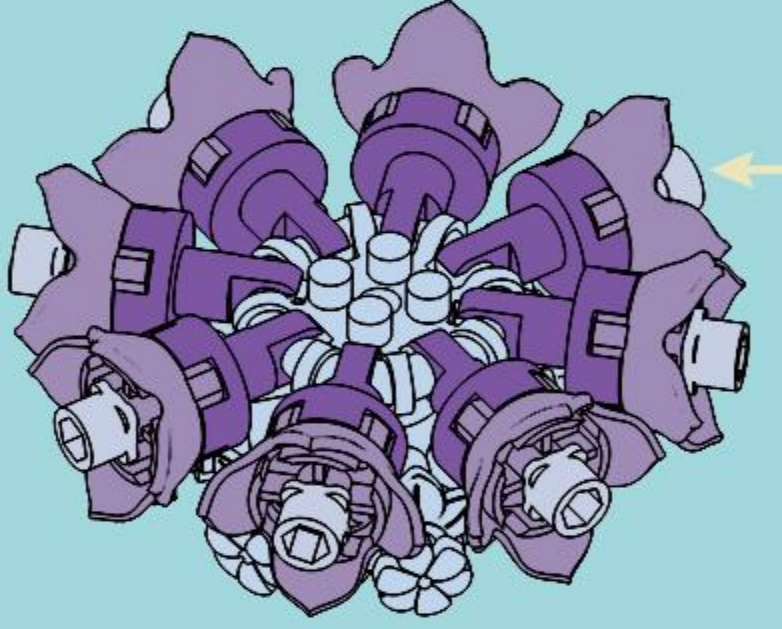

19

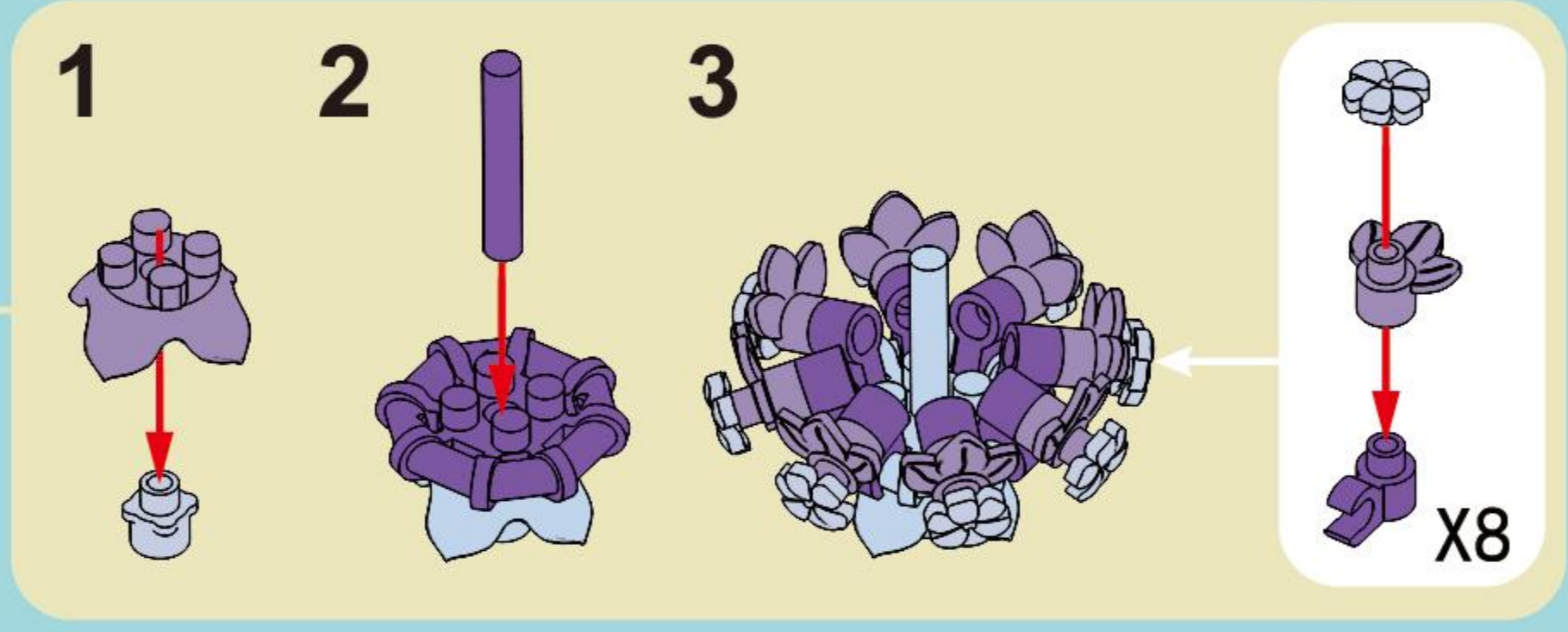
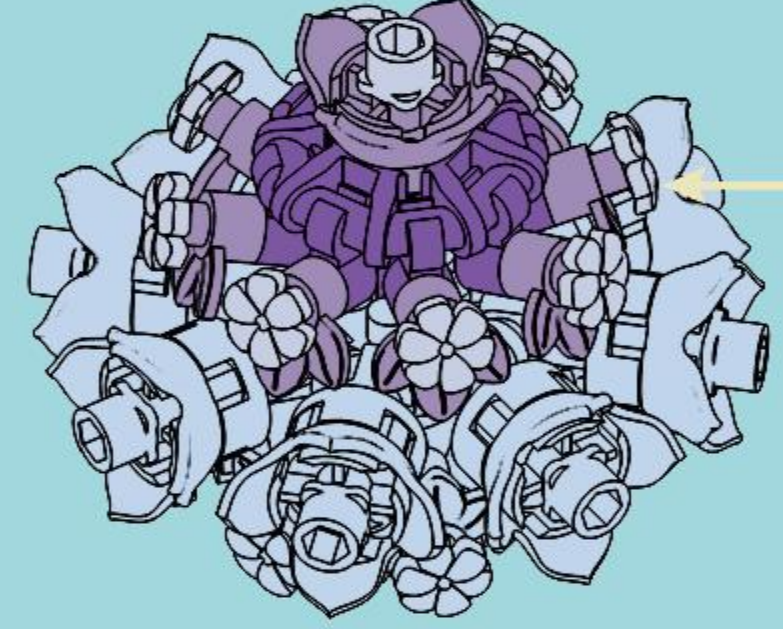

20

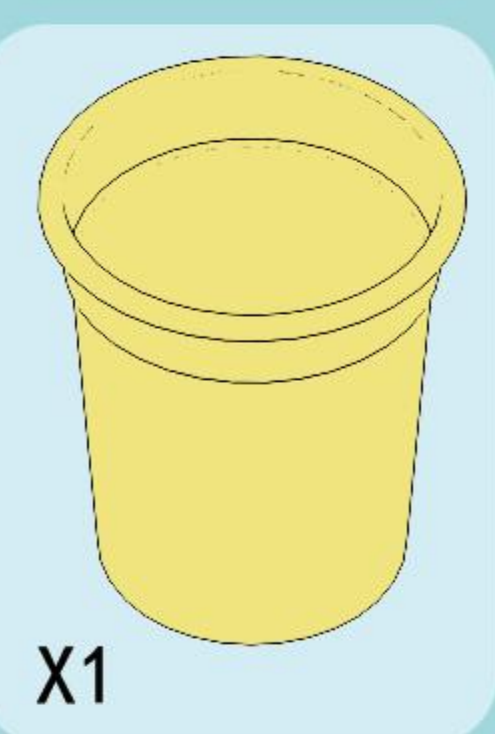
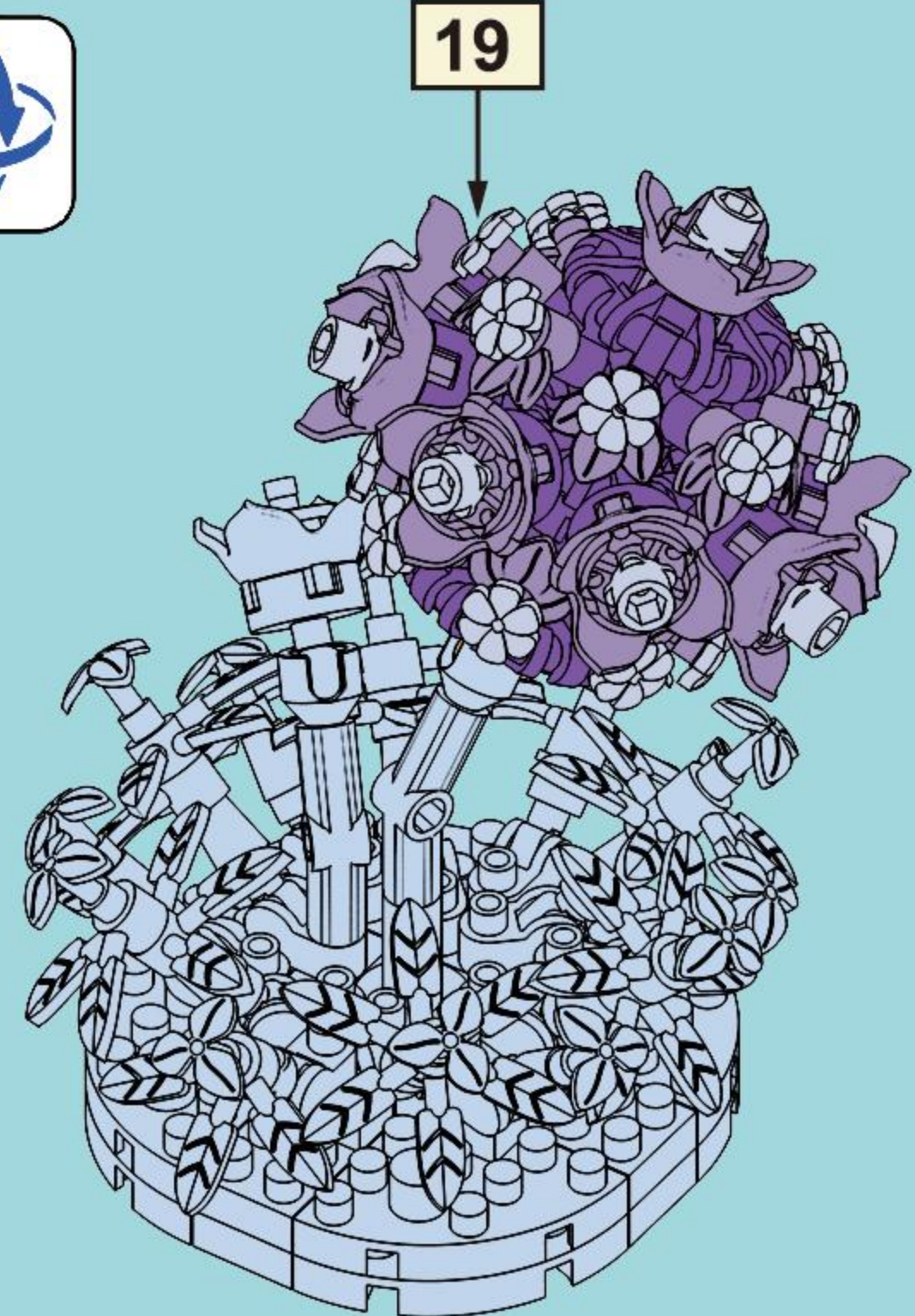

21

